

ROBAM



User Manual

Before operating this unit, please read the user manual completely and keep it. If the manual is lost, you can send e-mail to overseas@robam.com, request for an electronic manual.

CXW-260-56H1S

Range Hood

CONTENTS

Safety Precaution.....	1
Important Information.....	4
Product Description.....	5
Packing List.....	5
Installation.....	6
User Manual.....	9
Maintenance.....	10
Removal of Components.....	10
Circuit Diagram.....	13
Troubleshooting of General faults.....	13

Dear users:



Thank for your buying our range hood. Please accept our best regards. Please read this user manual carefully before installation and operation.

*The pictures in this manual only for your reference. If the picture isn't accord with object, subject to object. We keep to right to update appearance, structure or products without notice.

Safety Precaution

In order to avoid harm or property damage to the users or other person, the following distinction and marks are stipulated. They are important safety precaution, please comply strictly based on the full understanding.

Subject to harmful or destruct degree







 Danger	If ignore this sign and operate product improperly, it's highly possible to cause danger, serious injury or fire.
 Warning	If ignore this sign and operate product improperly, it's possible to cause danger, serious injury or fire.
 Notice	If ignore this sign and operate product improperly, it's possible to cause injury or loss.

Notice and Prohibit Mark



 Prohibit	 Prohibit Flame	 Prohibit Touch	 Prohibit Touch by Wet Hand	 Prohibit Disassembly	 Strict Execution	 Necessary Earthed	 Caution Electric Shock	 Caution Scald
---	--	--	--	--	--	--	--	---

 Warning Please use this product according to manual strictly, or ROBAM shall not take any responsible caused by improper operation.









Danger

 Prohibit	Don't allow children or weakling to use range hood separately, or it may cause electric shock or other accident.
 Prohibit	Prohibit water on motor, switches or other electric parts; Prohibit wash range hood by water spray. Don't use range hood if wet or it may cause electric leakage or shock.
 Prohibit	Don't change, stretch, bind or press electric wire, or it's possible to cause electric shock or fire because of broken wire.
 Prohibit	Prohibit any change of interior circuit, or it may cause injury or other danger, for example, electric shock or fire.
 Prohibit Touch by Wet Hand	Don't touch plug, electric parts or button by wet hands, or it may cause electric shock.
 Strict Execution	Unplug before cleaning, installing or maintaining, avoiding from electric shock.







Danger

 Strict Execution	<p>Please turn off range hood immediately if pan got fire (range hood shall aggravate fire if it's working) and extinguish fire by effective action. For example, cover flame by metal cover, turn off gas valve immediately and remove inflammable things.</p>
 Strict Execution	<p>Any abnormal, please turn off power, take off plug or cut off electric source, and contact service. It's possible to cause electric shock or fire if using range hood under abnormal situation.</p>



Warning

 Prohibit Disassembly	<p>Range hood must be installed, disassembled or maintained by professional person.</p>
 Prohibit	<p>Stove fire shall be extinguished timely when it is not used; do not flambe under the range hood and it's prohibited to bake food under range hood directly to prevent range hood from damaging and causing accidents.</p>
 Prohibit Touch	<p>Don't touch bulb if it's on or just close in short time, or it may cause scald.</p>
 Strict Execution	<p>In order to ensure safety, range hood must be installed by specific accessory (especially expansion pipe and wooden screws, or it may cause accidental drop of range hood). The pipe bore and hole must fit tightly during the installation of metal expansion pipe. It is prohibited to make excessively large hole to prevent accidental drop of loosening expansion pipe.</p>
 Strict Execution	<p>The range hood must be used by specific plug and properly ground it. It's possible to cause electric shock, hot plug or fire because of improper electric wire. Installation must be executed by professional person based on local electrical regulations. Before connect electricity, power must be turned off.</p>
 Strict Execution	<p>If the supply cord is damaged, it must be replaced by the manufacturer, its service agent or similarly qualified persons in order to avoid a hazard.</p>
 Strict Execution	<p>All operation must comply with our safety guidelines as well as local safety regulations.</p>
 Strict Execution	<p>There shall be adequate ventilation of the room when the range hood is used at the same time as appliances burning gas or other fuels.</p>
 Strict Execution	<p>This appliance just for household use only. And it's not allowed to exhaust dangerous or explosive matter or air. It should be put under dry and ventilation environment without dangerous air.</p>







Warning

 Strict Execution	The range hood and electric circuit must be installed by skilled and trained personnel with required qualification. When installation, the related regulation, standard or instruction on fire must be complied. It may cause danger because of improper installation, for example, electric shock, drop or fire accident.
 Strict Execution	The outlet must be connect with outside. In order to ensure safety and fresh air, waste gas should be exhaust to outside. Don't exhaust waste gas to the wall, loft or garage.
 Strict Execution	There is a fire risk if cleaning is not carried out in accordance with the instructions.
 Strict Execution	Keep a good habit to turn off gas hob and gas valve if go outside, sleep or finish operation. Replace or check gas pipe regularly, since gas alarm device can't completely avoid accident caused by gas leakage.
 Strict Execution	This appliance is not intended for use by persons (including children) with reduced physical, sensory or mental capabilities, or lack of experience and knowledge, unless they have been given supervision or instruction concerning use of the appliance by a person responsible for their safety. Children should be supervised to ensure that they do not play with the appliance.
 Strict Execution	The minimum distance between the supporting surface for the cooking vessels on the hob and the lowest part of the range hood. When the range hood is located above a gas appliance, this distance shall be at least 650mm. If the instructions for installation for the gas hob specify a greater distance, this has to be taken into account.
 Strict Execution	Range hoods and other cooking fume extractors may adversely affect the safe operation of appliances burning gas or other fuels (including those in other rooms) due to back flow of combustion gases. These gases can potentially result in carbon monoxide poisoning. After installation of a range hood or other cooking fume extractor, the operation of flued gas appliances should be tested by a competent person to ensure that back flow of combustion gases does not occur.

Notice

 Prohibit	The air must not be discharged into a flue that is used for exhausting fumes from appliances burning gas or other fuels, the discharge of air must fulfill the requirements of local regulations.
 Strict Execution	Before removing range hood for installation, clean or maintainance, power must be cut off avoiding from electric shock. When installation, clean or maintainance, protective gloove must wear avoiding from injury.

Notice

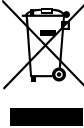
 Strict Execution	<p>The temperature for range hood working can't exceed 40°C.</p>
 Strict Execution	<p>Because the installation is difficult and hood is heavy, the installation shall be executed by professional person based on manual.</p>
 Strict Execution	<p>Don't break electric wire or other invisible equipment when cutting something or drilling holes on ceiling.</p>
 Strict Execution	<p>When range hood is using in well sealed building, it should have air inlet or open door to ensure good ventilation.</p>
 Strict Execution	<p>When the oil exceeds 2/3 or near tick mark in the oil cup, clean it in time. Don't eat waste oil from oil cup.</p>
 Strict Execution	<p>The wall of installing range hood needs enough strength. For hollow walls, the thickness of solid layer of hollow wall must be more than 30mm, but for concrete walls, it can be drill holes directly. The range hood must be fixed on the wall firmly.</p>
 Strict Execution	<p>CAUTION: Accessible parts may become hot when used with cooking appliances.</p>
	<p>DISPOSAL: Do not dispose this product as unsorted municipal waste. Collection of such waste separately for special treatment is necessary. This product must not be disposed together with the domestic waste. This product has to be disposed at an authorized place for recycling of electrical and electronic appliances. By collecting and recycling waste, you help save natural resources, and make sure the product is disposed in an environmental friendly and healthy way.</p>

Important Information

Package of Range Hood

Please settle those packages carefully in order to protect environment. Don't allow children to play plastic film and package, it may cause asphyxia. Please avoid children near package material.

Before use Range Hood

This range hood exhaust fume outside. Please read this manual and all information carefully before installation and operation. Please comply with our suggestion. If it's necessary, please read manual for gas hob. And please keep these manual carefully for future reference. If range hood has obvious damage, please don't electrify and contact operator. This manual is available for different models. So you may find different description with your own range hood.

Product Description

Technical Data

Model		CXW-260-56H1S	Noise	High	46dB(A)
Rated Voltage		220V-240V~		Low	40dB(A)
Rated Frequency		50Hz	Rated Power Input		262W
Nominal Wind Pressure		580Pa	Rated Main Motor Power Input		260W
Max static pressure		1050Pa	Lamp Power(max)		2W
Airflow	High	960m ³ /h	Dimension (L×W×H)		(895×353×645)mm
	Turbo	1440m ³ /h	Net Weight		26kg

- Note: 1. The performance test results are all in 230V~ 50Hz power supply environment. The noise in according to IEC 60704.
 2. The determined value of nominal wind pressure,max static pressure,airflow shall not be less than 90% of declared value.
 3. The noise declared value shown is A weighted sound pressure level.

Body Size

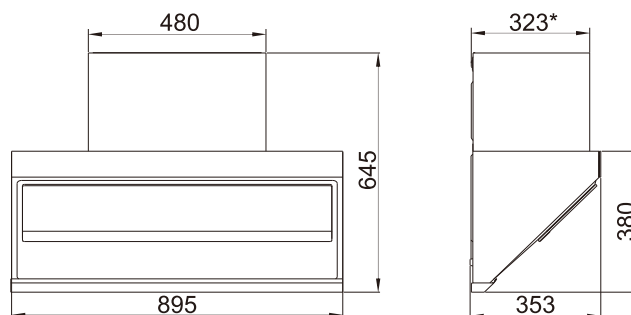

The marked sizes are for reference only, the depth dimension includes machine feet. (Unit: mm)

Note: If the hood is to be wrapped into the cabinet, the inside dimensions of the cabinet should be larger than the dimensions with *.323mm is the depth without the main panel, and 328mm with the main panel.

Packing List

Please check the items in the container upon unpacking

Packing List	No.	Name	Quantity	No.	Name	Quantity
	1	Range hood	1	5	Oil cup	1
	2	Ø185(outer diameter) aluminum exhaust pipe	1	6	Pothook	1
	3	User manual	1	7	Accessory packs	1
	4	Check valve	1			

Installation

 If the flue aperture is less than air duct aperture, it will influence the fume suction effect and the too long air duct will influence the fume suction effect, too.

Preparation for installation

● Surrounding

Keep the hood away from too many doors and windows, so as to avoid air convection affecting the efficiency.

● Tools preparation

The hood will be installed with the following tools

1. an impact drill (with drill bit); 2. a wrench; 3. a screwdriver; 4. a ruler.

Notice

- Installation and circuit setting must be done by experienced professionals. Only a professionally trained person with an installation qualification can install the hood. Non-professionals are not allowed to install, dismantle and repair the hood.
- Please do not power on the hood before installation to avoid electric shock.
- Do not expose the hood if your kitchen is under renovation, because construction materials, dusts, paint, coatings, and emitted gases will corrode and tarnish the hood surface. Therefore, it is recommended to install it after the renovation is completed.
- If you need move the Gas Hob before installing the Range Hood, please close the main valve before moving the Gas Hob.
- Don't install the hood on wood and other combustible walls. The wall shall be made of noncombustible materials with enough strength and the surface shall be flat.
- The hood may have very sharp edges. So, please wear protective gloves during hood installation, cleaning or repair.
- When drilling on the wall or ceiling board, keep away from embedded wires and other concealed devices to avoid electric shock and fire.
- Do not install the hood at a too high position as well as keep the hood free from disturbance of ambient airflow lest the reduction of smoke pumping effect shall occur.
- When making cabinet, please leave space for installation and disassembly of the hood in order to maintain and overhaul the hood.
- When installing, please keep the machine body remain horizontal.
- Please use single phase grounded socket and the hood shall be well grounded (water pipe grounding is not reliable and gas pipeline grounding has risks of causing fire disaster and explosion).
- In order to ensure safety and successful installation, please use standard accessories provided with the hood for installation, otherwise the hood may be at risk of falling down.
- If the power cord is damaged, in order to avoid danger, it must be replaced by manufacturer, professionals of its maintenance department or similar departments. Please do not carry out restructuring, stretching, knotting and squeezing or apply heavy objects to the power cord, etc., otherwise it may cause power cord damage easily, leading to accidents such as electric shock and fire disaster, etc.
- The installation height of the mounting section is only applicable to electric cookers. The minimum distance between the supporting surface for the cooking vessels on the hob and the lowest part of the range hood. When the range hood is located above a gas appliance, this distance shall be at least 650mm. If the instructions for installation for the gas hob specify a greater distance, this has to be taken into account.
- After installation, please clean the surface of the hood, and then supply power for test run.

Installation

Note: All data in synoptic diagram below are recommended dimensions, and units are expressed in mm.

● Determine the location: Cabinet pre-drilling dimensions as shown in Figure 1, in order to ensure a good operating experience, it is recommended that the top of the fume hood is flush with the bottom of the suspended cabinets. Ceiling drilling dimensions as shown in Figure 2, it is recommended to install the socket position above the ceiling.

Figure 1

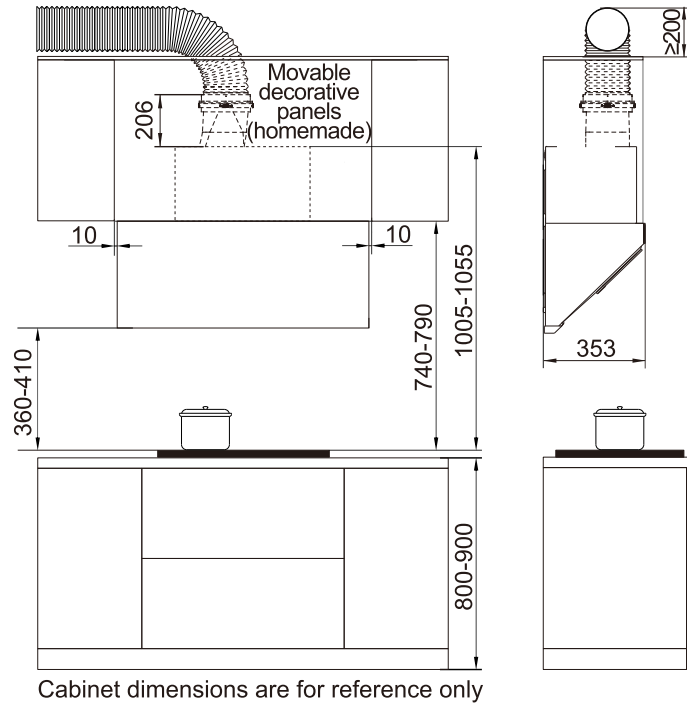
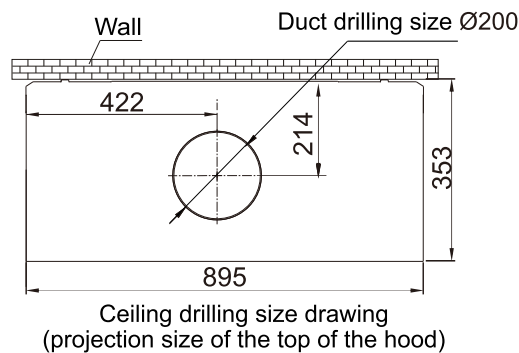

Figure 2



● Installation of pothook

According to the size of the pothook in the corresponding position on the wall, using a 10mm diameter drill bit to drill four holes with a depth of 60mm-70mm(not too big), press the expansion tube into the hole, and then use the four Cross countersunk head wood screws provided to fix the pothook reliably. At a height of 38mm from the four holes, drill a hole with a diameter of 10mm (not too large)。

Figure 3

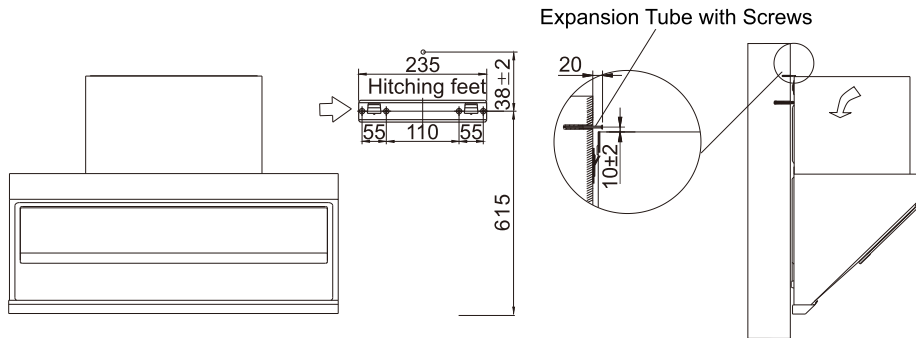

● Install hood body

First, the check valve as shown in Figure 5 fixed, and then in accordance with Figure 3 will be the rear of the body of the hanging hole aligned with the hook of the pothook pressed and slid into, shaking the body by hand to see if hung firmly. Once the body is in place, use 4.2 x 80mm screws to screw into the holes at 38mm, with the end of the screws spaced about 20mm from the wall.

Connection the aluminum exhaust pipe

● Drilling position of the aluminum exhaust pipe (public flues do not require drilling)

- Aluminum exhaust pipe and hob facing the window: Remove one of the glasses and install a plywood with ventilation holes or punch directly on the glass.
- Hob away from the window: Install the aluminum exhaust pipe through the window that is close to the hob and connected outside; or install it by punching on the wall that is close to the hob and connected outside.
- Drill hole through the wall: Determine the location of the aluminum exhaust pipe against the wall and draw the drilling range (i.e. a circle slightly larger than the pipe OD). Then use a long drill bit to drill through the wall. Pay attention to the wall structure and material, so as not to destroy other parts of the wall.

● Link the aluminum exhaust pipe

First, straighten the aluminum exhaust pipe, put the end without duct fixing strip on the public flue interface and tape it (if there is no public flue, please pull the duct directly to the outdoor). When the public flue interface or wall hole is larger than the aluminum exhaust pipe, it can be directly connected, when it is smaller than the duct, you can choose the duct interface. First, put one end of the aluminum exhaust pipe without duct fixing strip on the duct interface with tape, and then connect it with the public flue interface. The small end of the duct connector has five specifications: 140mm, 150mm, 160mm, 170mm, and 180mm outside diameter, and the excess part smaller than the public flue connector or wall hole can be cut off according to the actual situation.

Then, insert the end of the aluminum foil duct with the duct fixing strip on the outer ring of the check valve interface, and fix it with three ST4.2x8 screws distributed and sealed with duct tape. Finally, put the four snaps of the check valve interface into the four slots of the check valve and rotate clockwise to fix the duct on the check valve.

Figure 4

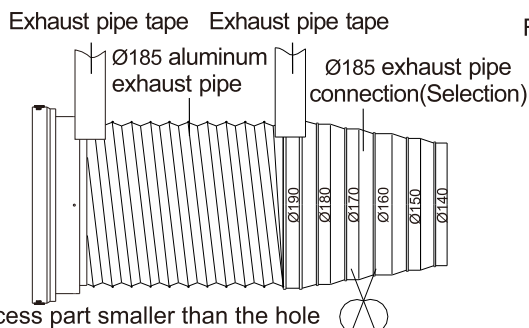
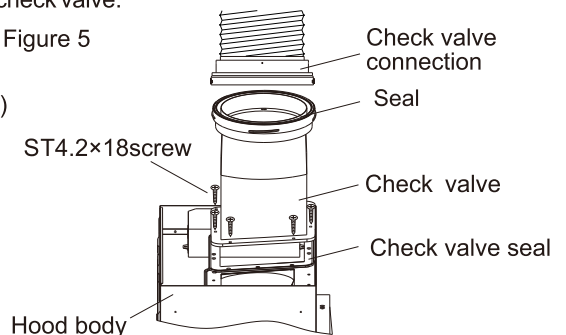

Figure 5



Note: During installation, straighten the aluminum exhaust pipe to avoid noises in semi-stretched state. Excess part may be cut with a wire cutter.



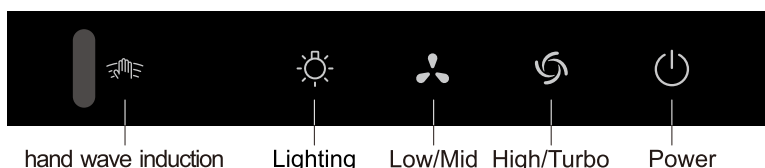

The exhaust wall hole diameter shall be close to that of the exhaust pipe, which shall not be too small. Otherwise, it will cause poor exhaust efficiency, more noises and lower volume, etc. The connection between the pipe and the hole or the public flue must be sealed tightly to ensure that, the pipe and the check valve or public flue is connected securely. The blades at the public flue connection must be flexible. Recommendation: When the range hood is matched with the anti-smoke back check valve, there is no need to install the range hood with its own check valve blade. If the use of the self-contained air outlet seat blade, in the switching machine may appear blade open and close the sound, is a normal phenomenon.

User Manual

Switch control panel



Turn on the power, the buzzer sounds, prompting to enter the power-on state.

 <p>Power</p>	<p>In the power off state, press the power button to enter the standby state and the power icon is long lit.</p> <ol style="list-style-type: none"> ① If only the light is on, pressing the power button again will turn off the light directly; ② If the fan is working when the power is on, press the power button and the power icon blinks. The smoker enters a delayed operating state for 1 minute before all functions are turned off; ③ If you press the power button again while the power icon is blinking, all functions are turned off. ④ In standby mode, if there is no operation within 3 minutes, it will enter the shutdown mode.
 <p>Low/Mid</p>	<p>In the power on state:</p> <ol style="list-style-type: none"> ① Press the low/mid key, the low/mid icon is long lit, and the fan activate works in low gear; ② Press the low/mid key again, the low/mid icon blinks to enter the Mid work; ③ Press this key repeatedly to cycle the fan between "low gear - mid gear".
 <p>High/Turbo</p>	<p>In the power on state:</p> <ol style="list-style-type: none"> ① Press the high/turbo key, the high/turbo icon will light up and enter the high operation state; ② Press the high/turbo key again, the high/turbo icon blinks, and the fan activate turbo gear, the nearly 3 minutes after the automatic switch to the high gear, this time the icon long light, into the high gear running state; ③ Press this key repeatedly to cycle the fan between "high gear - turbo gear".
 <p>Lighting</p>	<p>Pressing the lighting key turns the light on, pressing the lighting key again turns the light off, and the lighting key controls lighting only.</p>
 <p>Hand wave induction</p>	<ol style="list-style-type: none"> ① Under the off state, the first wave of the hand automatically turns on the power button; the second wave of the hand responds to the high-speed function; the high-speed state wave of the hand responds to the stir-fry function. ② Under the off state, long press the high/turbo button + low/mid button at the same time can turn the sensor function on or off. If users are not accustomed to use this function, it is recommended to turn off its induction function.



Cleaning Lock

Under the state of shutdown, simultaneously long press the low/mid key + lighting key to enter the cleaning lock state, the low/mid and lighting key icon will be long lighted, the air guide and lighting will be opened automatically, and the fan will be turned off. At this time, except for the following keys, the other keys are invalid.

- ① Press the lighting key, the lighting turns off, the low/mid and lighting icons flash slowly, press the lighting key again, the lighting turns on, the low/mid and lighting icons light up for a long time, and so on;
- ② Simultaneously long press the low/mid key + lighting key to exit the cleaning lock state, enter the shutdown state, and turn off the air guide and lighting.

Maintenance

Notice

- The hood should be regularly maintained and cleaned depending on the environmental conditions to keep the body clean and effective and to extend its service life. We recommend: wipe the exterior of the product after each cooking; to ensure the smooth discharge of oil smoke, the oil net depending on the use of frequent cleaning (in the frying state and then click the frying gear, to be fully open baffle cut off the power, before the oil net cleaning), please be careful when washing, prohibit the use of industrial cleaning agents containing acetone, butanone, so as not to damage the hydrophilic coating on the surface of the oil net.
- It is recommended to use a neutral detergent to clean instead of strong detergents, and dry with a soft cloth. If your range hood is a mechanical switch, you should also avoid detergent touching each control key.
- Do not allow stains to stay on the surface of the hood for too long.
- Please do not use cleaning balls, brushes and other rough objects to clean the hood to prevent the hood body surface from scratching.
- When cleaning or maintaining the hood, please wear protective gloves to prevent wounding during wiping.
- Please regularly check and clean the oil cup. As shown in the right figure, hold the oil cup with both hands, pull it out and pour out the waste oil.
- The range hood shall be started before cooking.
- Please unplug it during long-term shutdown, but please do not pull hard.



Removal of Components

Note: The installation procedures of the following components are in reverse with the removal. Please wear protective gloves during operation to prevent the sharp edge of metal hurting your hands.

- ⚠ Disassembly must be carried out by professionals, and users are not allowed to carry out disassembly. Unplug before installing or disassembling, avoiding from electric shock.

Removal of lamp

- Simultaneously press and hold the low/mid key + lighting key to enter the cleaning lock state, so that the air guide is open, and then unplug the power supply.
- Insert a screwdriver into the gap of the LED lamp circumference and pry out the LED lamp for repair and replacement.

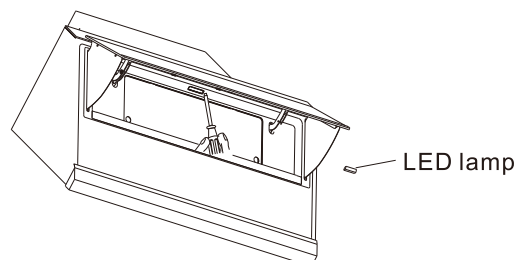

Lamp image	Lamp information	
	Lamp Type	Rectangular LED
	Max Power	2W
	Voltage	12VDC
	Dimension	See the lamp image

Removal of switch

- Use a screwdriver or flat metal object to insert into the gap between the fume hood and the glass panel, corresponding to the snap position slightly force outward, remove the glass panel.
- Use a screwdriver to unscrew the 2 screws on the switch, remove the switch, and unplug the connection cable to repair and replace it.

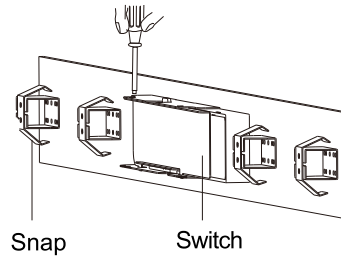
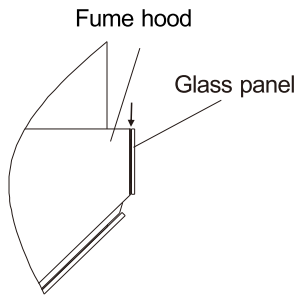

Removal of filter

- Simultaneously press and hold the low/mid key + lighting key to enter the cleaning lock state, so that the air guide is open, and then unplug the power supply.
- Pull the two portable holes on the filter with both hands, slightly force outward so that the filter is no longer sucked, then pull out the filter in the direction of the arrow so that it is out of the slot, and finally pull out the filter outward, you can clean the filter.

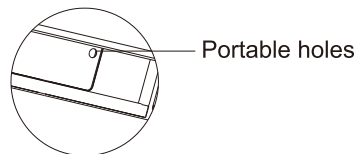
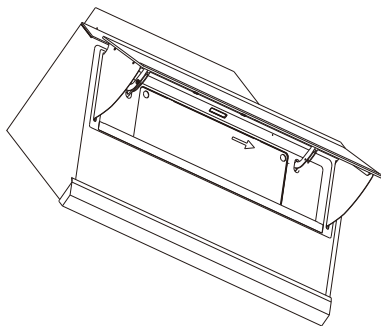

Removal of the hole range hood

1. Close the air guide and unplug the power supply;
2. Unscrew the screws on the left and right cover panels, remove the left and right cover panels, then unscrew the screws on the back panel and rear panel of the enclosure, remove the back panel and rear panel of the enclosure, and then unscrew the 6 screws on the air outlet of the air duct and remove the air duct;
3. Unscrew the 4 screws on the retaining ring and remove the ring, then screw down the cap clockwise and remove the impeller vertically;
4. Remove the filter by following the steps in "Removal of filter";
5. Remove the lamp by following the steps in "Removal of lamp";
6. Remove the switch by following the steps in "Removal of switch";

The mounting procedure is the reverse of the dismantling procedure.

(When putting on the impeller, please smear some lubricant in the shaft hole of the impeller.)



In general, the range hood body does not need to remove. The removal needs to be completed by professional maintenance staff.

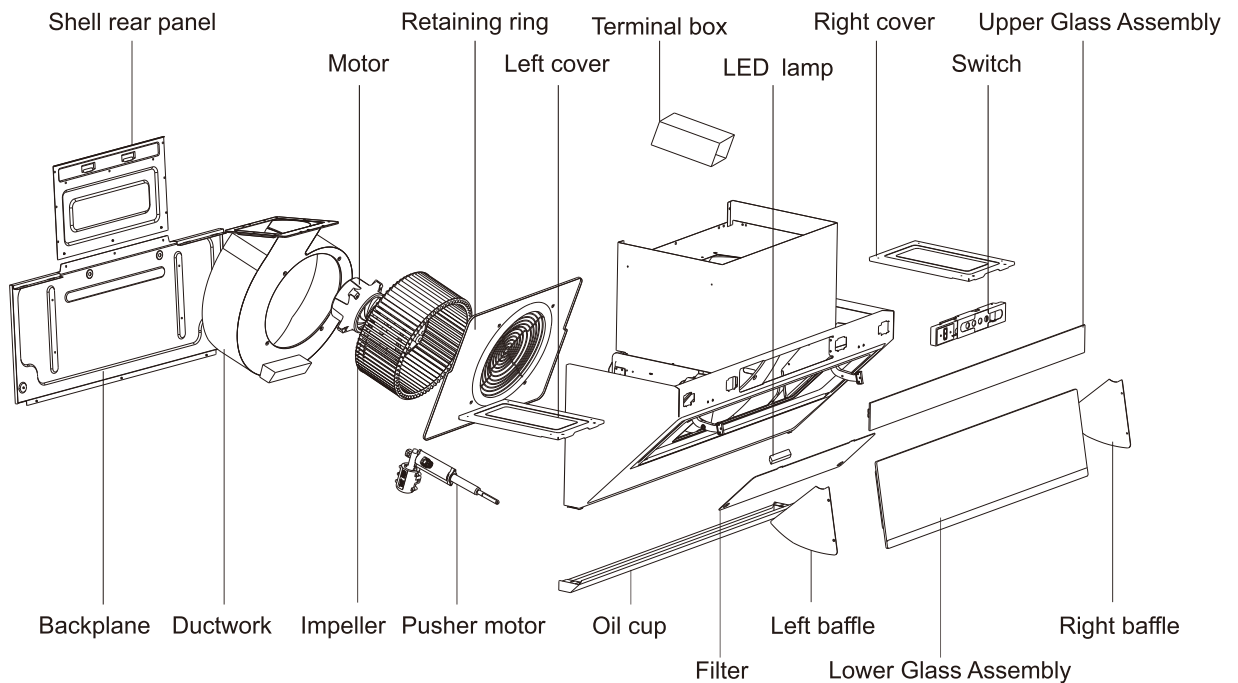

Circuit Diagram

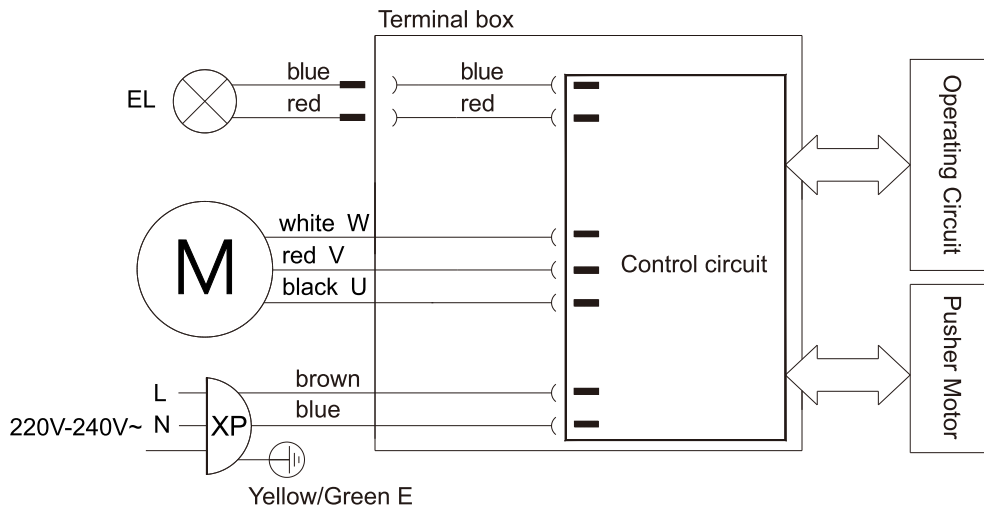

Troubleshooting of General faults

Serial number	Fault	Cause	Solution
1	No response after pressing any icon (e. g. the impeller does not rotate, or the light is off)	The power plug is not connected properly or there is power failure	Plug in the power plug
2	Pressing the lighting icon, the headlamp is not lit	The light is damaged or poorly connected	Replace the light or plug in the plug
3	Induced current exists on the hood body may paralyze hands	The power socket is not grounded well	Use single-phase three-pole socket and well grounded
4	Abnormal sound during impeller running	The impeller is loose, and the cap is not tightened	Tighten the cap
5	No oil in the oil cup after a period of time	The hood body is tilt	Adjust the hood body to the horizontal state
6	Open the air guide in the process of hearing a few beeps prompt, or the air guide can not open completely	Electric actuator drive circuit failure, or electric actuator failure, or electric actuator wire poor contact	Contact a repair professional
 Warning	1. When connecting or replacing the plug, please unplug the power plug. 2. If the range hood's power cords are damaged, it must be replaced by our company's professional maintenance staff.		

Edition: A/0

Publication Date: October, 20, 2023

ROBAM